

IGBT

Features

- 1200V,75A
- $V_{CE(sat)(typ.)}=1.6V@V_{GE}=15V,I_C=75A$
- Optimized for minimum saturation voltage
- Low operation frequencies (<1kHz)
- Industry standard TO-247 package

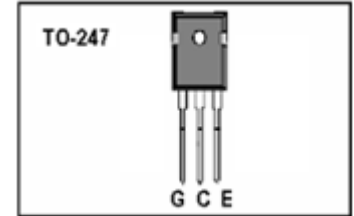

General Description

JIAEN FS-IGBTs offer highest efficiency available for application such as PTC heating.

Absolute Maximum Ratings

Symbol	Parameter	Value	Units
V_{CES}	Collector-Emitter Voltage	1200	V
V_{GES}	Gate-Emitter Voltage	± 30	V
I_C	Continuous Collector Current ($T_C=25^\circ C$)	150	A
	Continuous Collector Current ($T_C=100^\circ C$)	75	A
I_{CM}	Pulsed Collector Current (Note 1)	225	A
P_D	Maximum Power Dissipation ($T_C=25^\circ C$)	420	W
	Maximum Power Dissipation ($T_C=100^\circ C$)	210	W
T_J	Operating Junction Temperature Range	-55 to +175	$^\circ C$
T_{STG}	Storage Temperature Range	-55 to +150	$^\circ C$

Thermal Characteristics

Symbol	Parameter	Max.	Units
$R_{th\ j-c}$	Thermal Resistance, Junction to case for IGBT	0.36	$^\circ C/W$
$R_{th\ j-a}$	Thermal Resistance, Junction to Ambient	40	$^\circ C/W$

Electrical Characteristics ($T_C=25^\circ\text{C}$ unless otherwise noted)

Symbol	Parameter	Test Conditions	Min.	Typ.	Max.	Units
BV_{CES}	Collector-Emitter Breakdown Voltage	$V_{GE}=0V, I_C=250\mu A$	1200	-	-	V
I_{CES}	Collector-Emitter Leakage Current	$V_{CE}=1200V, V_{GE}=0V$	-	-	250	μA
I_{GES}	Gate Leakage Current, Forward	$V_{GE}=\pm 30V, V_{CE}=0V$	-	-	± 100	nA
$V_{GE(th)}$	Gate Threshold Voltage	$V_{GE}=V_{CE}, I_C=250\mu A$	4	-	6	V
$V_{CE(sat)}$	Collector-Emitter Saturation Voltage	$V_{GE}=15V, I_C=75A$	-	1.6		V
Q_g	Total Gate Charge	$V_{CC}=960V$ $V_{GE}=15V$ $I_C=75A$	-	172		nC
Q_{ge}	Gate-Emitter Charge		-	51.6		nC
Q_{gc}	Gate-Collector Charge		-	105.7		nC
$t_{d(on)}$	Turn-on Delay Time	$V_{CC}=600V$ $V_{GE}=15V$ $I_C=75A$ $R_G=15\Omega$ Inductive Load $T_C=25^\circ\text{C}$	-	53	-	ns
t_r	Turn-on Rise Time		-	137	-	ns
$t_{d(off)}$	Turn-off Delay Time		-	613	-	ns
t_f	Turn-off Fall Time		-	112	-	ns
E_{on}	Turn-on Switching Loss		-	6.8	-	mJ
E_{off}	Turn-off Switching Loss		-	6.5	-	mJ
E_{ts}	Total Switching Loss		-	13.3	-	mJ
C_{ies}	Input Capacitance	$V_{CE}=25V$ $V_{GE}=0V$ $f=1\text{MHz}$	-	3664	-	pF
C_{oes}	Output Capacitance		-	215	-	pF
C_{res}	Reverse Transfer Capacitance		-	39	-	pF

Notes:

1. Repetitive Rating: Pulse width limited by maximum junction temperature

Typical Performance Characteristics

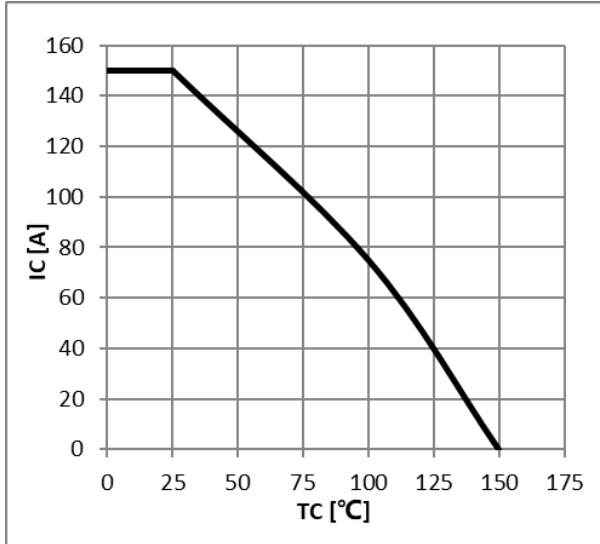

Figure 1: Maximum DC Collector Current VS. case temperature

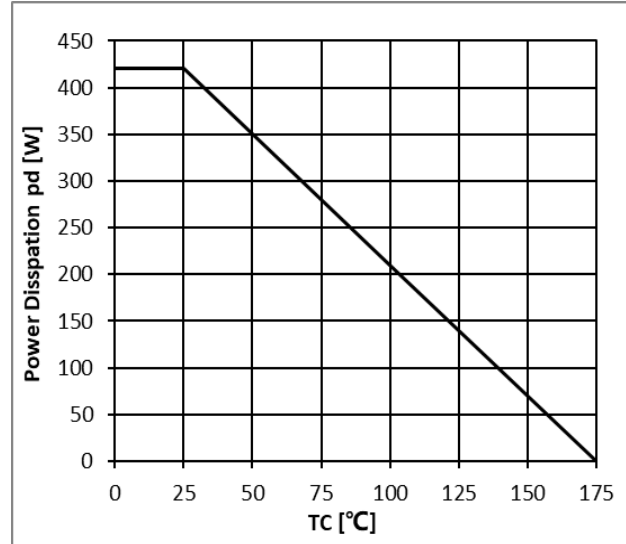

Figure 2: Power Dissipation VS. Case Temperature

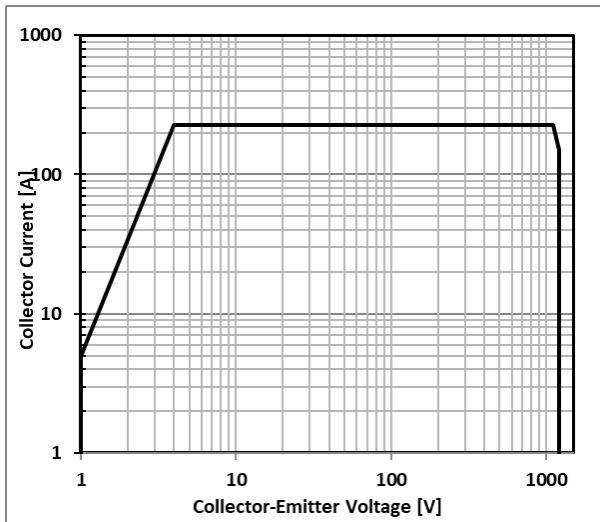

Figure 3: Reverse Bias SOA, $T_J=125^{\circ}\text{C}$, $V_{GE}=15\text{V}$

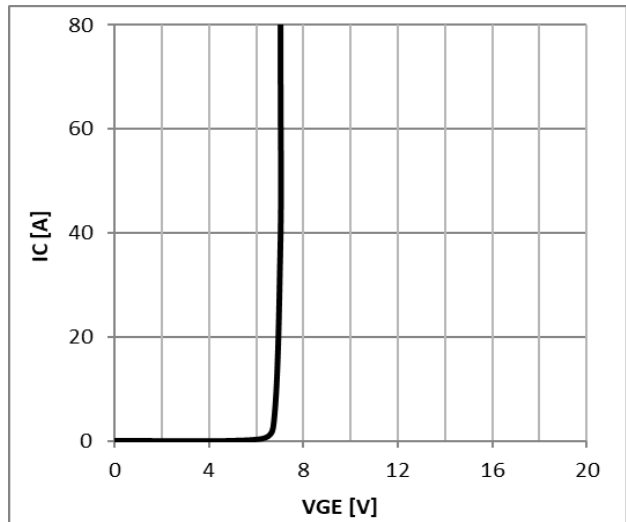

Figure 4: Typical Gate Threshold Voltage

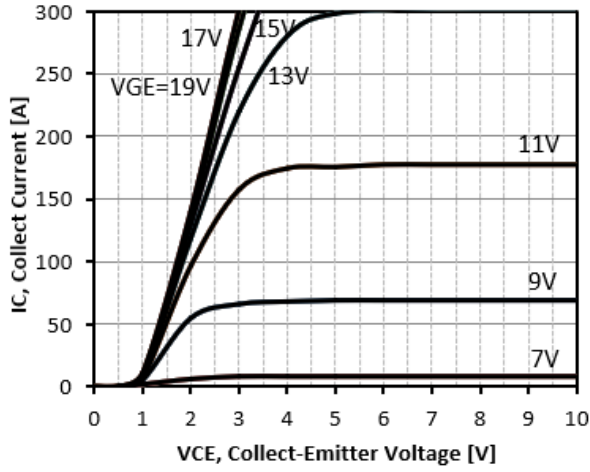

Figure 5: Typical IGBT Output characteristics,
 $T_J=25^{\circ}\text{C}; t_p=300\mu\text{s}$

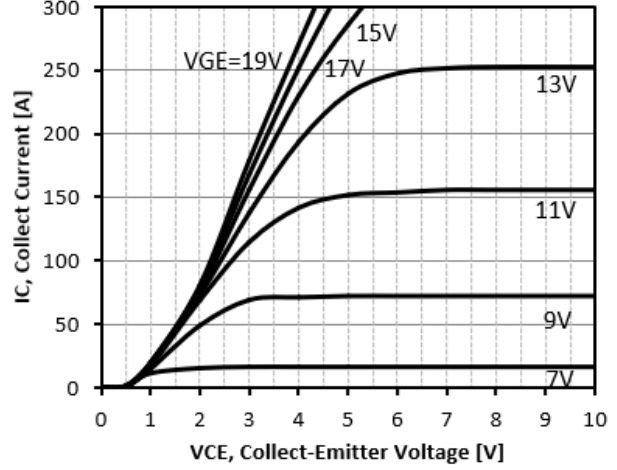

Figure 6: Typical IGBT Output characteristics,
 $T_J=150^{\circ}\text{C}; t_p=300\mu\text{s}$

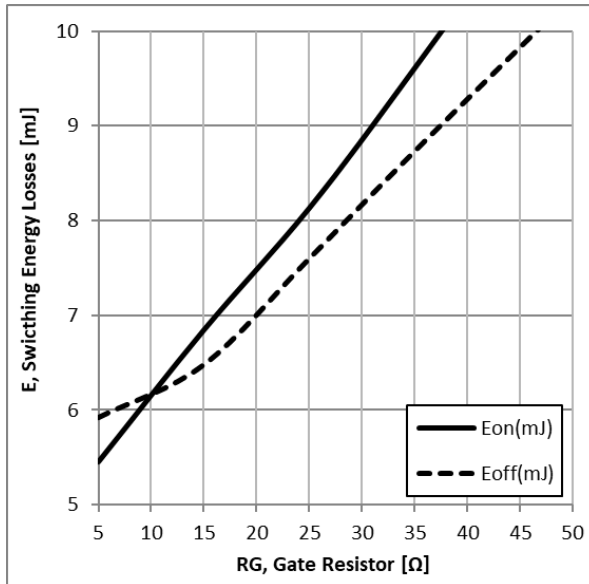

Figure 7: Typical Energy Loss VS. R_G , $T_C=25^{\circ}\text{C}$,
 $L=200\mu\text{H}, V_{CE}=600\text{V}, V_{GE}=15\text{V}, I_C=75\text{A}$

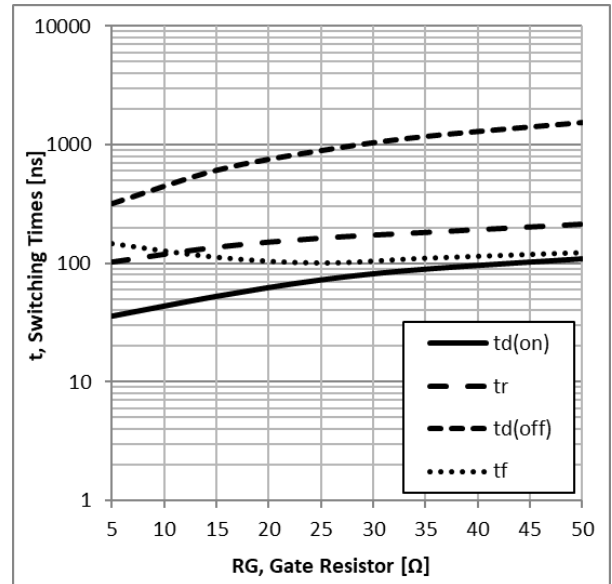

Figure 8: Typical Switching Time VS. R_G , $T_C=25^{\circ}\text{C}$,
 $L=200\mu\text{H}, V_{CE}=600\text{V}, V_{GE}=15\text{V}, I_C=75\text{A}$

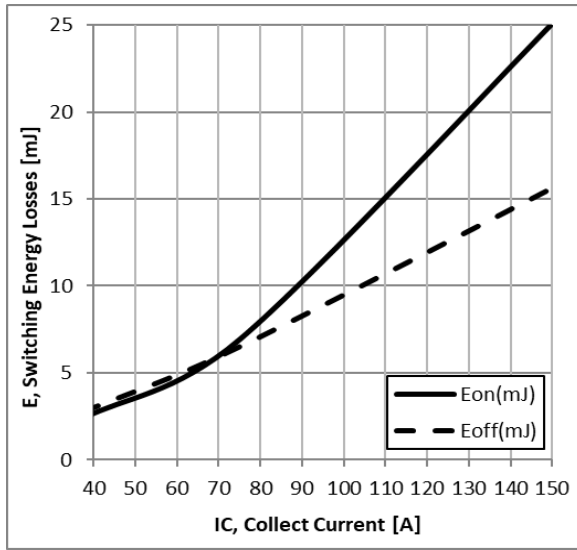

Figure 9: Typical Energy Loss VS. IC, TC=25°C,
L=200uH, VCE=600V, VGE=15V, RG=15 Ω

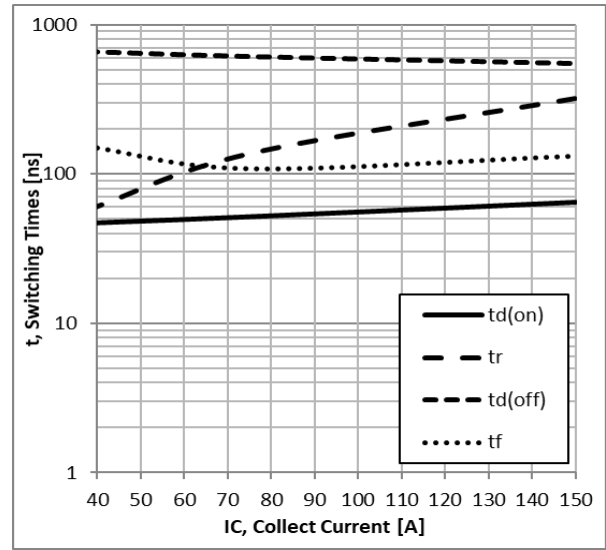

Figure 10: Typical Switching Time VS. IC, TC=25°C,
L=200uH, VCE=600V, VGE=15V, RG=15 Ω

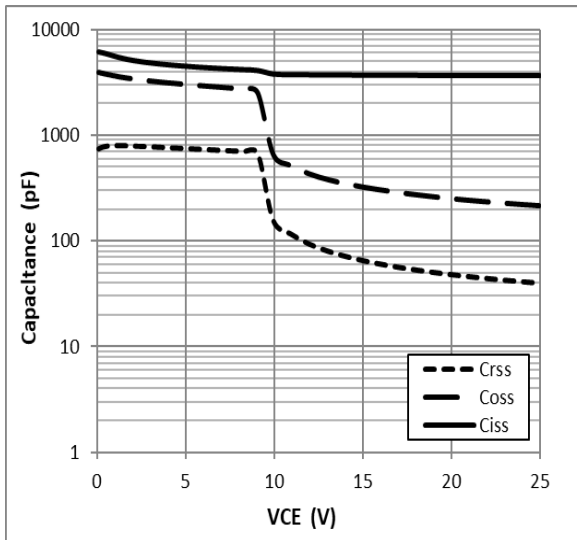

Figure 11: Typical Capacitance VS. VCE,
VGE=0V, f=1MHz

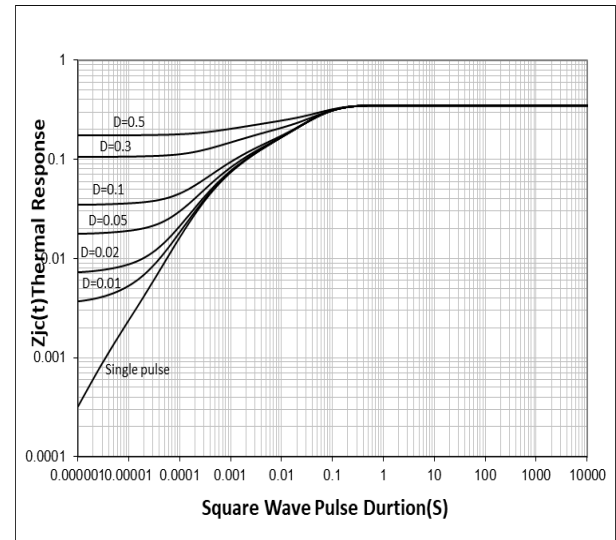
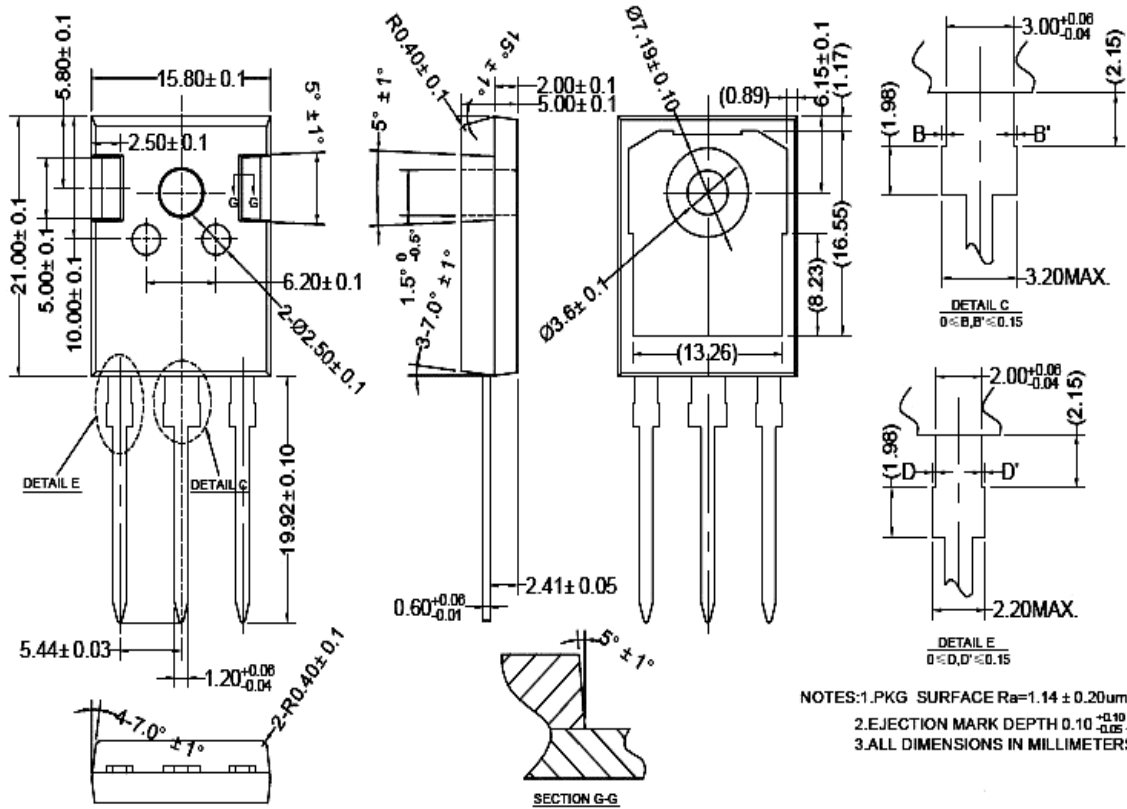

Figure 12: Normalized transient thermal impedance
junction-to-case

TO247 PACKAGE OUTLINE



NOTES:1.PKG SURFACE Ra=1.14 ± 0.20um.
2.EJECTION MARK DEPTH 0.10^{+0.10}/_{-0.05}.
3.ALL DIMENSIONS IN MILLIMETERS.

0 ≤ D, D' ≤ 0.15

NOTES:1.PKG SURFACE Ra=1.14 ± 0.20um.
2.EJECTION MARK DEPTH 0.10^{+0.10}/_{-0.05}.
3.ALL DIMENSIONS IN MILLIMETERS.

公差标注	公差值	表面粗糙度
0	±0.2	Ra3.2~6.3
0.0	±0.1	Ra1.6~3.2
0.00	±0.01	Ra0.8~1.6
0.000	±0.005	Ra0.4~0.8
0.0000	±0.002	Ra0.2~0.4

Disclaimers

JIAEN Semiconductor Co., Ltd reserves the right to make changes without notice in order to improve reliability, function or design and to discontinue any product or service without notice. Customers should obtain the latest relevant information before orders and should verify that such information is current and complete. All products are sold subject to JIAEN's terms and conditions supplied at the time of order acknowledgement.

JIAEN Semiconductor Co., Ltd warrants performance of its hardware products to the specifications at the time of sale, Testing, reliability and quality control are used to the extent JIAEN deems necessary to support this warrantee. Except where agreed upon by contractual agreement, testing of all parameters of each product is not necessarily performed.

JIAEN Semiconductor Co., Ltd does not assume any liability arising from the use of any product or circuit designs described herein. Customers are responsible for their products and applications using JIAEN's components. To minimize risk, customers must provide adequate design and operating safeguards.

JIAEN Semiconductor Co., Ltd does not warrant or convey any license either expressed or implied under its parent rights, nor the rights of others. Reproduction of information in JIAEN's datasheets or data books is permissible only if reproduction is without modification or alteration. Reproduction of this information with any alteration is an unfair and deceptive business practice. JIAEN Semiconductor Co., Ltd is not responsible or liable for such altered documentation.

Resale of JIAEN's products with statements different from or beyond the parameters stated by JIAEN Semiconductor Co., Ltd for that product or service voids all express or implied warranties for the associated JIAEN's product or service and is unfair and deceptive business practice. JIAEN Semiconductor Co., Ltd is not responsible or liable for any such statements.