

## 650V N-Channel MOSFET

### General Description

This Power MOSFET is produced using advanced planar stripe DMOS technology. This advanced technology has been especially tailored to minimize on-state resistance, provide superior switching performance, and withstand high energy pulse in the avalanche and commutation mode. These devices are well suited for high efficiency switched mode power supplies, active power factor correction based on half bridge topology.

### Features

- 10A, 650V,  $R_{DS(on)typ.} = 0.78\Omega @ V_{GS} = 10V$
- Low gate charge
- High ruggedness
- Fast switching
- Improved  $dv/dt$  capability

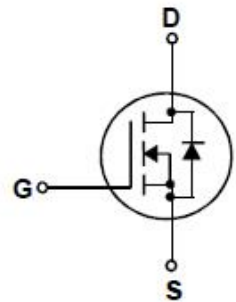
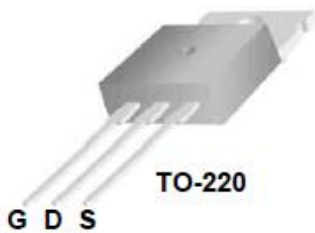

### Absolute Maximum Ratings $T_c = 25^\circ\text{C}$ unless otherwise noted

Symbol	Parameter	JFPC10N65C	JFFC10N65C	Units
$V_{DSS}$	Drain – Source Voltage	650		V
$I_D$	Drain Current	Continuous ( $T_c = 25^\circ\text{C}$ )	10	10*
		Continuous ( $T_c = 100^\circ\text{C}$ )	6	6*
$I_{DM}$	Drain Current - Pulsed (Note 1)	40		A
$V_{GSS}$	Gate – Source Voltage	$\pm 30$		V
EAS	Single Pulsed Avalanche Energy (Note 2)	160		mJ
$I_{AR}$	Avalanche Current (Note 1)	10		A
$E_{AR}$	Repetitive Avalanche Energy (Note 1)	18.6		mJ
$dv/dt$	Peak Diode Recovery $dv/dt$ (Note 3)	4.5		V/ns
$P_D$	Power Dissipation ( $T_c = 25^\circ\text{C}$ ) -Derate above $25^\circ\text{C}$	186	39	W
		1.48	0.32	W/ $^\circ\text{C}$
$T_J, T_{STG}$	Operating and Storage Temperature Range	-55 to +150		$^\circ\text{C}$
$T_L$	Maximum lead temperature for soldering purposes 1/8" from case for 5 seconds	300		$^\circ\text{C}$

\*Drain current limited by maximum junction temperature.

## Thermal characteristics

Symbol	Parameter	JFPC10N65C	JFFC10N65C	Units
R <sub>θJC</sub>	Thermal Resistance, Junction-to-Case	0.67	3.15	°C/W
R <sub>θJS</sub>	Thermal Resistance, Case-to-Sink Typ.	0.5	--	°C/W
R <sub>θJA</sub>	Thermal Resistance, Junction-to-Ambient	62.5	62.5	°C/W

## Electrical Characteristics T<sub>c</sub> = 25 °C unless otherwise noted

Symbol	Parameter	Test Conditions	Min	Typ	Max	Units
<b>Off Characteristics</b>						
BV <sub>DSS</sub>	Drain – Source Breakdown Voltage	V <sub>GS</sub> = 0 V, I <sub>D</sub> = 250 μA	650	--	--	V
ΔBV <sub>DSS</sub> /ΔT <sub>J</sub>	Breakdown Voltage Temperature Coefficient	I <sub>D</sub> = 250 μA, Referenced to 25°C	--	0.6	--	V/°C
I <sub>DSS</sub>	Zero Gate Voltage Drain Current	V <sub>DS</sub> = 650 V, V <sub>GS</sub> = 0 V	--	--	1	μA
		V <sub>DS</sub> = 520 V, T <sub>c</sub> = 125 °C	--	--	10	μA
I <sub>GSSF</sub>	Gate-Body Leakage Current, Forward	V <sub>GS</sub> = 30 V, V <sub>DS</sub> = 0 V	--	--	100	nA
I <sub>GSSR</sub>	Gate-Body Leakage Current, Reverse	V <sub>GS</sub> = -30 V, V <sub>DS</sub> = 0 V	--	--	-100	nA
<b>On Characteristics</b>						
V <sub>GS(th)</sub>	Gate Threshold Voltage	V <sub>DS</sub> = V <sub>GS</sub> , I <sub>D</sub> = 250 μA	2.0	--	4.0	V
R <sub>DS(on)</sub>	Static Drain-Source on-Resistance	V <sub>GS</sub> = 10 V, I <sub>D</sub> = 5.0 A	--	0.78	0.83	Ω
g <sub>FS</sub>	Forward Transconductance	V <sub>DS</sub> = 40 V, I <sub>D</sub> = 5.0 A ( Note 4 )	--	8.8	--	S
<b>Dynamic Characteristics</b>						
C <sub>iss</sub>	Input Capacitance	V <sub>DS</sub> = 25 V, V <sub>GS</sub> = 0 V, f = 1.0 MHz	--	1609	--	pF
C <sub>oss</sub>	Output Capacitance		--	136	--	pF
C <sub>rss</sub>	Reverse Transfer Capacitance		--	7.9	--	pF
<b>Switching Characteristics</b>						
t <sub>d(on)</sub>	Turn-On Delay Time	V <sub>DS</sub> = 325 V, I <sub>D</sub> = 10.0 A, V <sub>GS</sub> = 10 V, R <sub>G</sub> = 25Ω ( Note 4,5 )	--	26	--	ns
t <sub>r</sub>	Turn-On Rise Time		--	23	--	ns
t <sub>d(off)</sub>	Turn-Off Delay Time		--	49	--	ns
t <sub>f</sub>	Turn-Off Fall Time		--	27	--	ns
Q <sub>g</sub>	Total Gate Charge	V <sub>DS</sub> = 520 V, I <sub>D</sub> = 10.0 A V <sub>GS</sub> = 10 V ( Note 4,5 )	--	32	--	nC
Q <sub>gs</sub>	Gate-Source Charge		--	8	--	nC
Q <sub>gd</sub>	Gate-Drain Charge		--	12	--	nC
<b>Drain – Source Diode Characteristics and Maximum Ratings</b>						
I <sub>S</sub>	Maximum Continuous Drain-Source Diode Forward Current		--	--	10	A
I <sub>SM</sub>	Maximum Pulsed Drain-Source Diode Forward Current		--	--	40	A
V <sub>SD</sub>	Drain-Source Diode Forward Voltage	V <sub>GS</sub> = 0 V, I <sub>S</sub> = 10.0 A	--	--	1.4	V
t <sub>rr</sub>	Reverse Recovery Time	V <sub>GS</sub> = 0 V, I <sub>S</sub> = 10.0 A	--	498	--	ns
Q <sub>rr</sub>	Reverse Recovery Charge	dI <sub>F</sub> /dt = 100 A/μs ( Note 4 )	--	2.94	--	μC

### Notes:

1. Repetitive Rating : Pulsed width limited by maximum junction temperature
2. L = 3mH , I<sub>AS</sub> = 10A, V<sub>DD</sub> = 50V, R<sub>G</sub> = 25Ω, Starting T<sub>J</sub> = 25°C
3. I<sub>SD</sub> ≤ 10.0A, di/dt ≤ 100A/μs, V<sub>DD</sub> ≤ BV<sub>DSS</sub>, Starting T<sub>J</sub> = 25°C
4. Pulsed Test : Pulsed width ≤ 300μs, Duty cycle ≤ 2%
5. Essentially independent of operating temperature

## Typical Characteristics

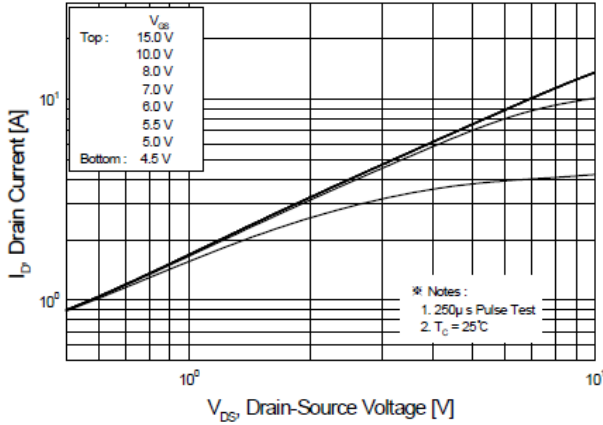

Figure 1. On-Region Characteristics

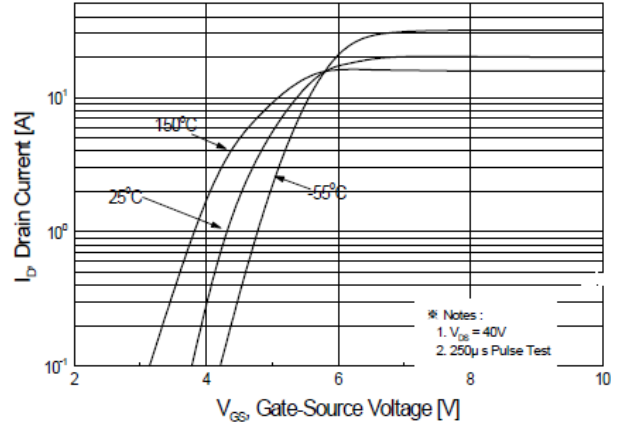

Figure 2. Transfer Characteristics

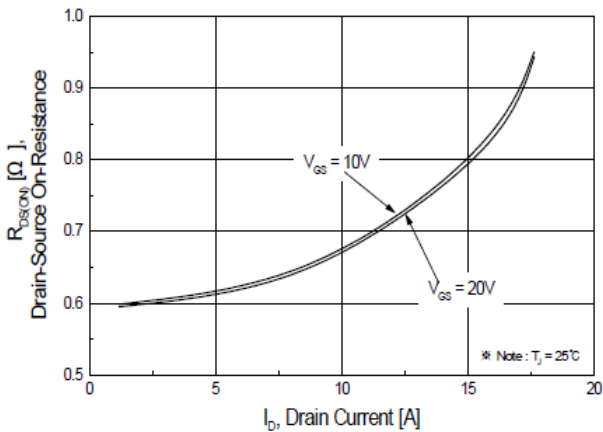

Figure 3. On-Resistance Variation vs Drain Current and Gate Voltage

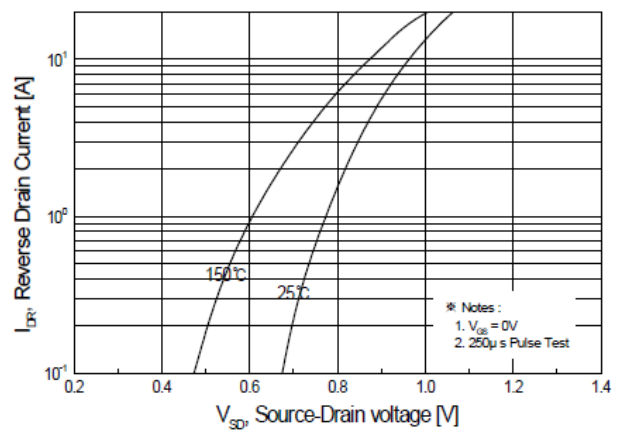

Figure 4. Body Diode Forward Voltage Variation with Source Current and Temperature

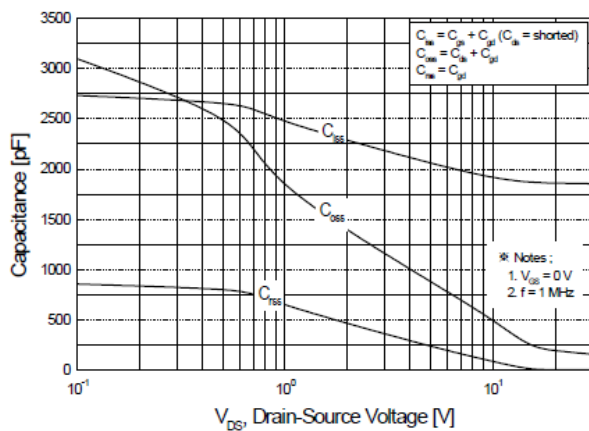

Figure 5. Capacitance Characteristics

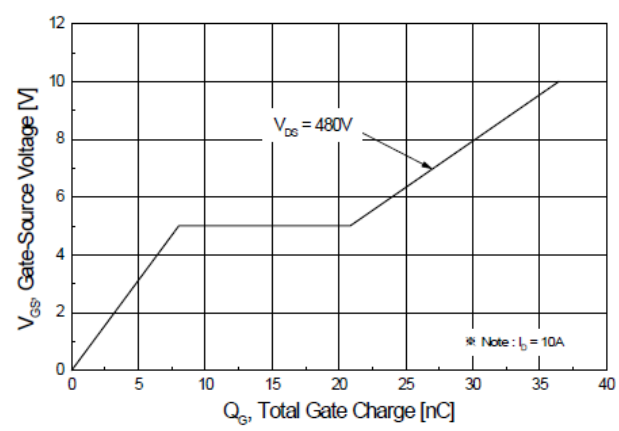

Figure 6. Gate Charge Characteristics

### Typical Characteristics

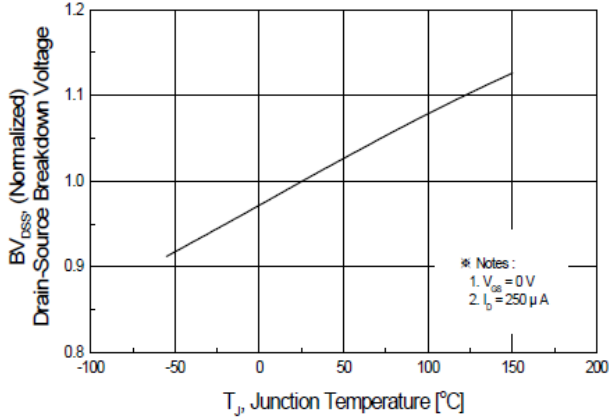

Figure 7. Breakdown Voltage Variation vs Temperature

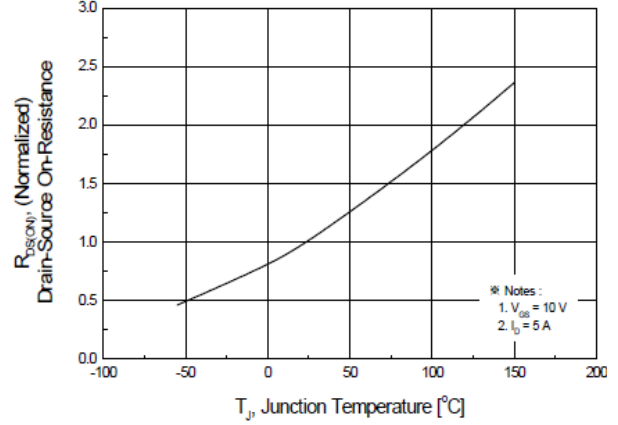

Figure 8. On-Resistance Variation vs Temperature

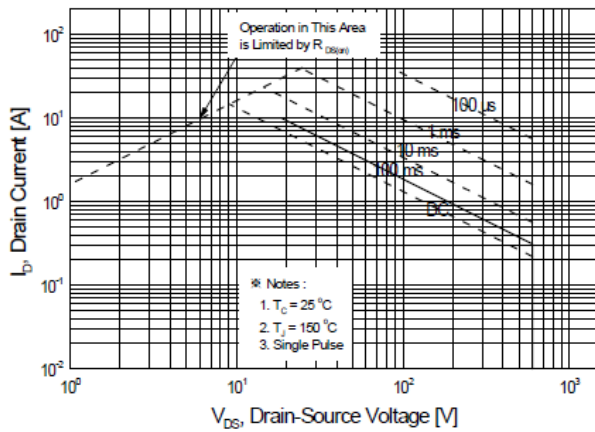

Figure 9-1. Maximum Safe Operating Area for JFPC10N65C

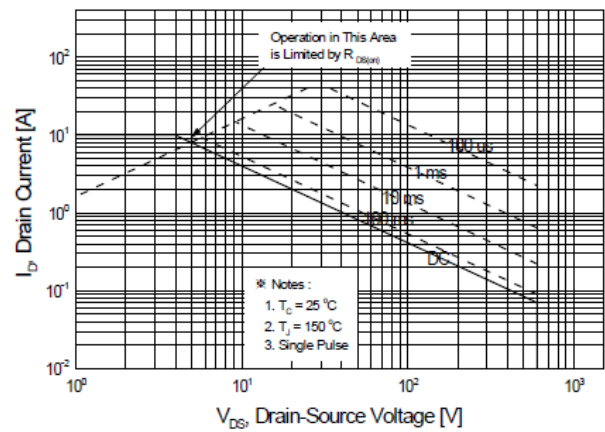

Figure 9-2. Maximum Safe Operating Area for JFFC10N65C

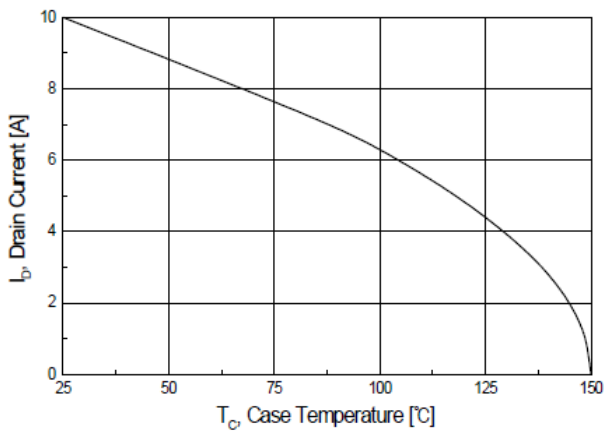

Figure 10. Maximum Drain Current vs Case Temperature

### Typical Characteristics

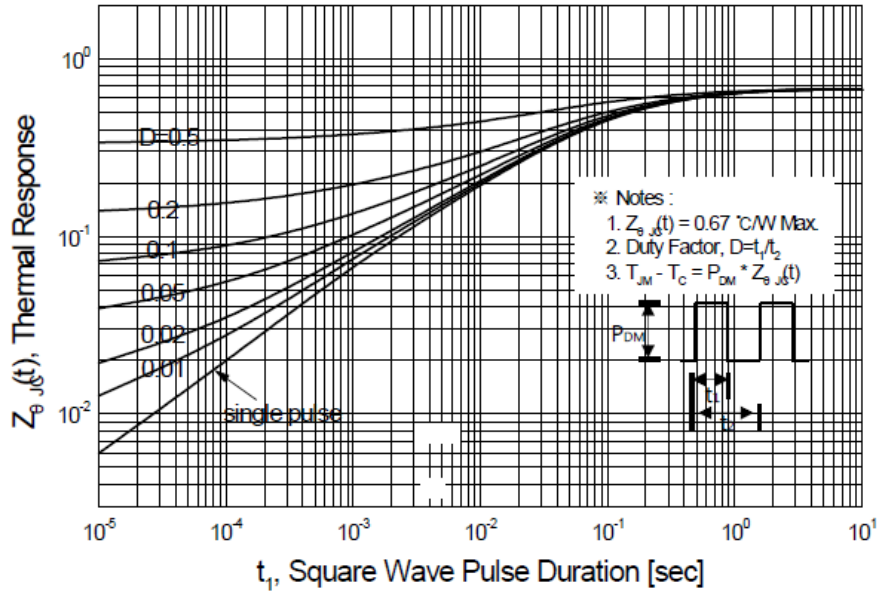

Figure 11-1. Transient Thermal Response Curve for JFPC10N65C

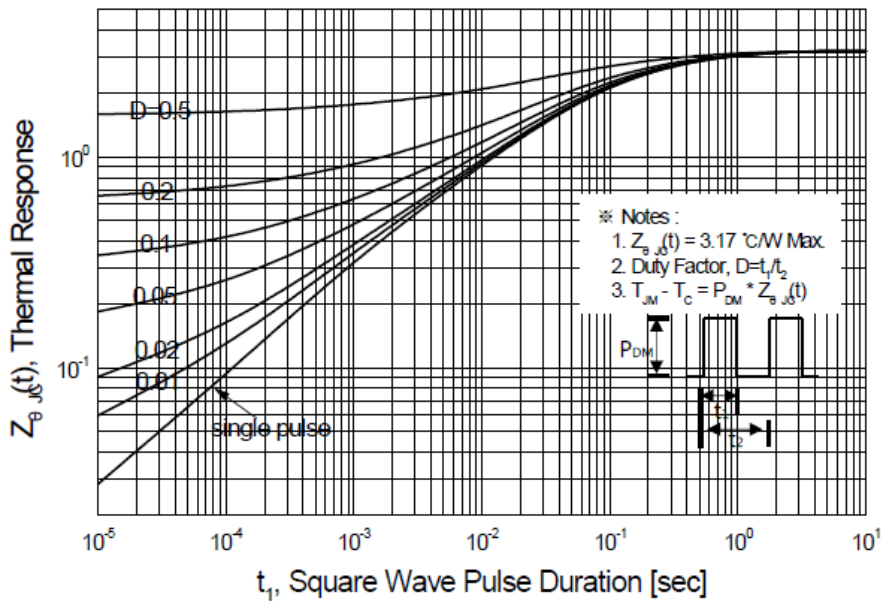
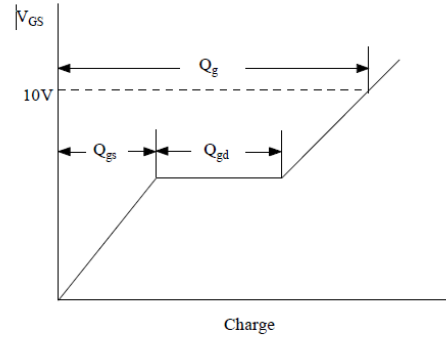
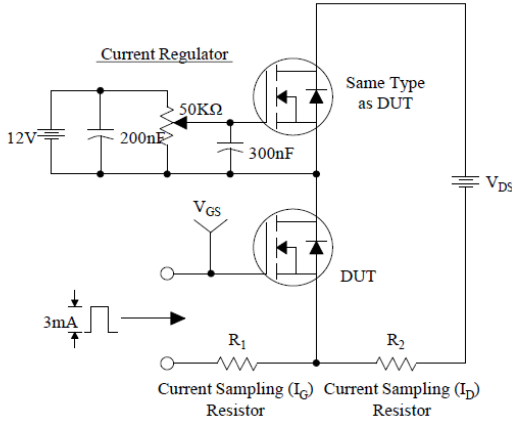
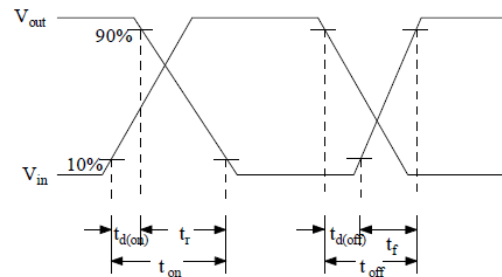
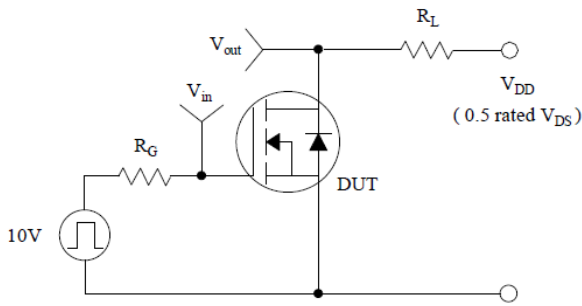

Figure 11-2. Transient Thermal Response Curve for JFFC10N65C

### Test Circuit & Waveform



Gate Charge Test Circuit & Waveform



Resistive Switching Test Circuit & Waveforms

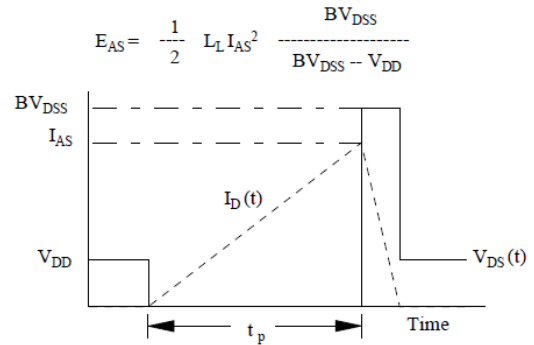
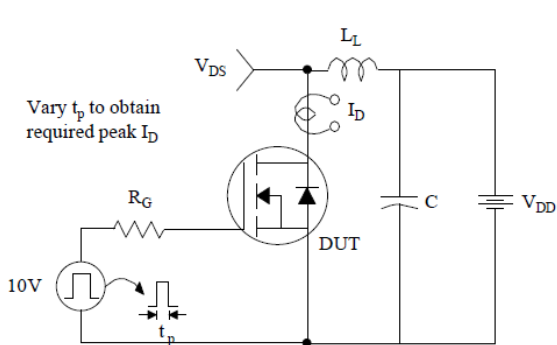

Unclamped Inductive Switching Test Circuit & Waveforms

### Test Circuit & Waveform

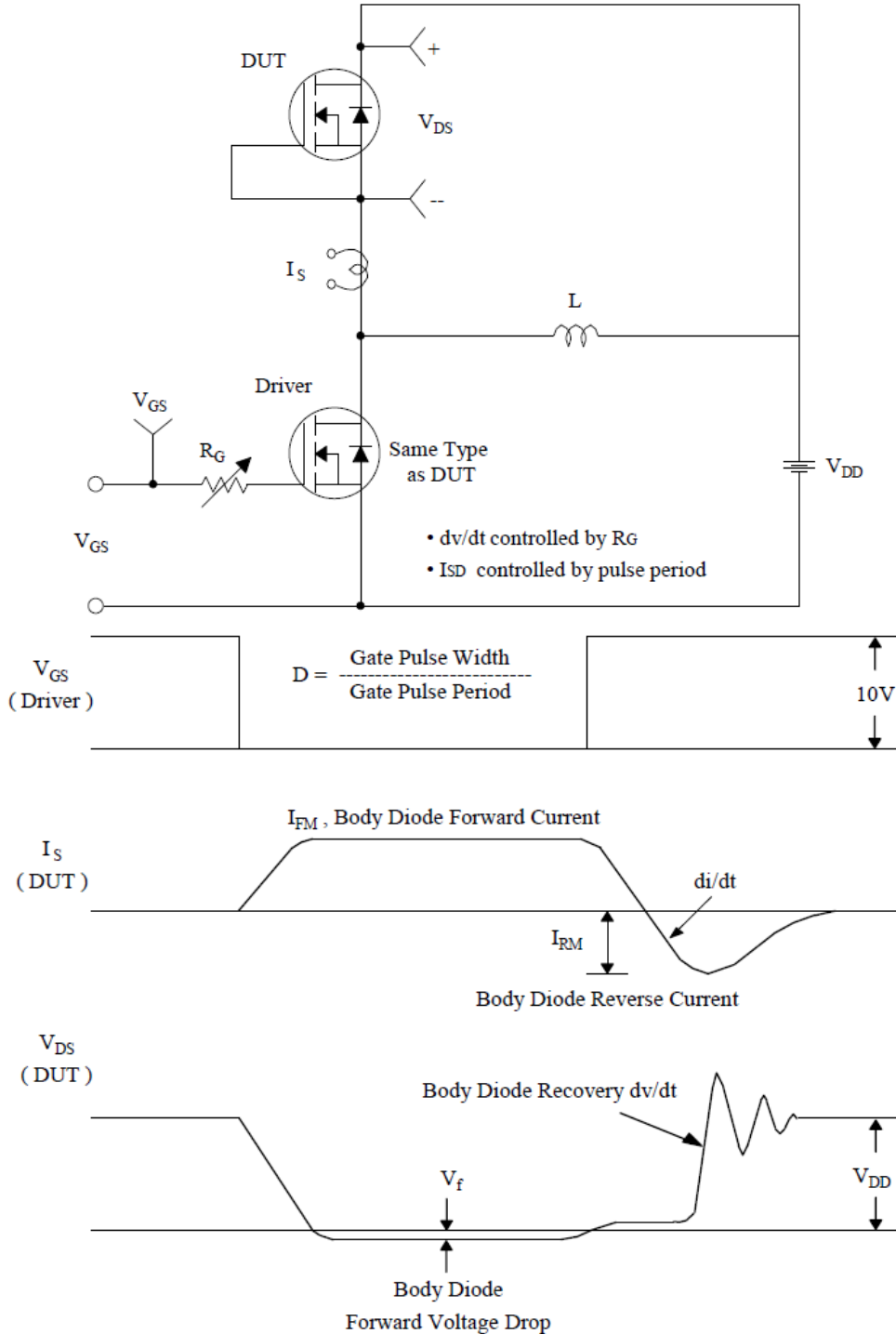

Peak Diode Recovery  $dv/dt$  Test Circuit & Waveforms